



Model LX3018
Owner's Manual
Outdoor Football Play Clock Set



The purpose of this document is to explain how to install and maintain Electro-Mech Model LX3018 Outdoor Football Play Clocks. Model LX3018 is typically sold as a pair of displays intended to be used in conjunction with an Electro-Mech Football scoreboard display. At the time of manufacture, the clocks may be configured either for permanent installation or for portable use. The portable configuration is compatible with Electro-Mech's T-Cart leg kit and includes a detachable AC power cord for each display. The permanently installed version is designed so that each cabinet mounts on a single post and provides terminal blocks for attaching power and data cables. Operation of the scoreboard system is covered in the manual that ships with the main control console.

TABLE OF CONTENTS

Best Practices for Personal Safety and Product Care 3

Product Specifications 5

Planning Your Scoreboard Installation 9

Mechanical Installation- Permanent Configuration 11

Mechanical Installation - Portable Configuration 15

Electrical Installation - Permanent Configuration 16

Electrical Installation - Portable Configuration 24

Testing, Operation, and Ongoing Care 26

Maintenance 28

Limited Warranty Statement 34

BEST PRACTICES FOR PERSONAL SAFETY AND PRODUCT CARE

Thank you for choosing Electro-Mech products for your athletic facility. We hope you will be pleased with the performance and appearance of your play clocks. The information in this document will help you maintain the equipment in its best condition.

Receiving Your Scoreboard

Depending on the shipping method, cardboard sheets, partially open wooden crates, or a set of complete enclosures may protect the play clock cabinets. It is important to inspect all packaging for damage when the cabinets arrive — *before signing any paperwork telling the trucking company that you have received everything in good condition*. If damage has occurred to the packaging, then damage may have occurred to the play clocks. Where you find dents, scrapes, or holes in the packaging, peel back the cardboard or other packing materials to expose the cabinet. Make notes on the paperwork provided by the trucking company before accepting delivery. If the damage appears to be severe, refuse the shipment. Contact Electro-Mech as soon as possible if you suspect shipping damage.

We recommend keeping the play clock cabinets in their packing materials until the day of installation. It is important to keep the packing materials dry while they are on the scoreboard. Wet cardboard can adhere to surfaces and damage the finish.

If your play clock cabinets arrives in wooden crates, take care to avoid scraping the cabinets with tools, nails, or lumber when prying apart the nailed sections. Make certain to pry the wooden pieces apart from each other rather than trying to apply force against a scoreboard cabinet. Aluminum is strong, but a steel crowbar is stronger.

Once the crate is out of the way, remove the cardboard padding. You may need to remove a few labels adhered to the sides of the cabinets for shipping. At this point, your play clock cabinets are unpacked and ready for installation.

Storage Prior to Installation

Unless you are planning to install your play clocks on the same day that they arrive, you will need to prepare a clean, dry, secure area for storage. Even though your play clock displays are designed ruggedly, you will need to keep them away from moisture, dirt, accidental damage, and abuse.

Stand the play clock cabinets upright prior to assembly; never lay them facing up or down. Never stack things on top of the cabinets while they are in storage.

These recommendations apply equally to ID panels and other items that may have shipped with your play clock displays.

Conditions of Installation and Use for Outdoor Play Clock Sets

This play clock set is designed for installation and use in a wet environment. That is, rain and other common weather conditions will not hinder the operation of this product when it is installed correctly. The play clock cabinets are not watertight. Instead, they are designed to withstand normal outdoor conditions by routing water through each cabinet and out of drain holes in the bottom. Do not block the drain holes. Allow 1/4-inch or more clearance below each play clock cabinet. If either play clock display is to be installed immediately above something — for instance, an ID panel or the ledge of a wall — please allow 1/4-inch or more clearance below the cabinet. Alternatively, you could provide matching drain holes in the top of the object below a play clock.

Outdoor play clock displays are typically installed on steel posts. It is important to properly install these posts and allow concrete footings time to cure before using them to support the play clock cabinets.

When the play clock displays are not in use, disconnect them from power. We recommend installing a dedicated disconnect switch on one of the mounting posts beneath each display. In the "off" position, the switch should isolate all load-carrying conductors (not the ground). This will help protect the play clock electronics from nearby lightning strikes and other power fluctuations that might otherwise travel along the power cables.

PRODUCT SPECIFICATIONS

General Description:

- Model LX3018 is a pair of electronic scoreboard displays intended primarily to serve as Play Clocks (a.k.a. Delay of Game Timers) for American football. These displays can also serve as Shot Clocks for lacrosse or other field sports.

Standard Package Includes:

- Two scoreboard cabinets
- Four mounting clamp assemblies (when configured for permanent installation)
- Two detachable power cables with GFCI feature (when configured for portable use)
- One control console
- One wired 3-button hand-held play clock switch assembly
- Two stereo patch cables
- Two junction boxes (when configured to use hardwired data cable)

Cabinet Dimensions and Weight:

- 35 in (W) x 35 in (H) x 4 in (D), 30 lb each

Cabinet Construction and Finish:

- Each cabinet is formed from sheet aluminum. The masks protecting the illuminated digits are also made from aluminum sheet material. Mask and outer cabinet pieces are finished with enamel paint. Optional accent striping and other decorative elements are cut from exterior grade vinyl. Electro-Mech offers eighteen standard paint and vinyl colors. Other color options are available as an upgrade.

Overview of LED Display Circuit Boards:

- Red or amber LEDs (light emitting diodes) mounted on PCBs (printed circuit boards) form all lighted digits. The color choice is determined at the time of purchase. All illuminated PCBs include conformal coating for weather protection. The circuit boards are mounted behind aluminum masks, painted black to increase contrast. The masks allow the epoxy shells of the LEDs to protrude past the scoreboard face, maximizing viewing angle while providing impact-absorbing protection from contact with stray balls and other flying objects. The LEDs may be dimmed to reduce glare during night games. They are rated for 100,000 hours of use.

Display Features:

- 2-Digit Play Clock, 18 inches tall, counts down seconds from 99 or less to 0

Additional Standard Scoreboard Features:

- All serviceable components accessible from the front of the cabinet
- Two mounting options to choose from:
 - Select the standard Electro-Mech clamping system if you wish to permanently mount each cabinet on a single post. In this case, power must be hardwired to a terminal block inside the cabinet.
 - Select the portable mounting style for use with our optional leg kit or for installations that allow mounting hardware to be bolted to the sides of the cabinets. When configured for portable use, each cabinet is provided with a detachable power cable.

Control Console:

- The console includes custom software running on an internal microprocessor, a 32-character LCD display, a 37-button sealed membrane keypad, and a 6-ft. power cord. The console enclosure consists of an ABS plastic base and top with a metal back plate.
- Four data output ports can each directly drive a play clock or scoreboard display through a single cable run and indirectly drive up to ten displays in perfect synchronization via daisy chaining. The number of synchronized displays is practically limitless when using the optional ScoreLink RF communications system.
- Allows two programmable reset values for play clock time.
- The software includes support for Practice Segment Timer Mode, 50 levels of brightness, and other features.

Optional Equipment and Features:

- Data cable for hard-wired installations (two runs required)
- ScoreLink RF communications system for wireless data transmission (two receiver units required)
- Hard carrying case for control console and accessories
- Wireless hand-held play clock switch assembly for sideline operation
- T-Card leg kit for portable use (Note that the leg kit is not an option for play clocks configured for permanent installation.)

Power Requirements:

- Each LX3018 play clock display requires one circuit providing 0.4 amps, 120 VAC, 60 Hz
- When the displays are configured for portable use, their detachable power cords must be plugged into standard (NEMA 5-15R) power receptacles. The power cords should be unplugged when the displays are not in use.
- When the displays are configured for permanent installation, Electro-Mech recommends installing a dedicated breaker to control power to each play clock display.
- The control console requires one circuit providing 0.5 amps, 120 VAC, 60 Hz via a standard (NEMA 5-15R) power receptacle.
- Each scoreboard cabinet must be properly grounded.

Mounting Requirements (Permanent Configuration):

- In this configuration, each play clock display is designed to be mounted on a single post.
- The cross-section dimension (width and depth) of the post should not exceed 7-1/2 inches.
- The mounting clamps provided with this scoreboard allow the cabinets to be attached to properly sized and positioned posts without the need for welding, drilling, or fabricating brackets on site.

Mounting Requirements (Portable Configuration):

- In this configuration, each play clock display is designed to be supported on each side. This support is typically provided by the two leg pieces of Electro-Mech's optional T-Cart leg kit. However, the cabinets may be bolted to a variety of permanent or portable structures.
- Each cabinet will fit between two posts or brackets spaced 35 inches apart.
- Support posts or brackets may be attached to each cabinet using a pair of 1/2-inch-13 bolts on each side.
- To receive these bolts, the hardware inside the cabinets is tapped with holes vertically spaced 9 inches center-to-center.

Safety Listing, Support, and Warranty Information:

- All LX-series scoreboard displays are ETL Listed to UL Standard 48 for Electric Signs.
- Electro-Mech offers technical support at no charge over the phone or via the Internet for the life of the product.
- The standard limited warranty covers factory labor on parts returned to Electro-Mech within five years of the scoreboard's date of invoice.
- Additional support plans are available.
- The complete standard warranty statement is included near the end of this document available.

PLANNING YOUR SCOREBOARD INSTALLATION

A good plan is important to the success of any project, and installing a scoreboard is no exception. An important first step in planning for your scoreboard is determining its optimal location. Key factors here are visibility and accessibility.

By "accessibility" we mean the ease with which you can get people, equipment, cabling, etc. to a scoreboard display during installation, as well as ease-of-access for future service. Positioning the display on a tall, steep embankment or backed up against a densely wooded area can add cost to installations as well as service calls.

By "visibility" we mean the ease with which spectators, participants, and the scoreboard operator can see the display. Because every playing field is unique, there is no one-size-fits-all way to describe the perfect scoreboard location. But we can tell you that, in the United States, your best bet is to put the scoreboard display on the South or West side of the field (facing North or East). This will reduce glare from the setting sun during afternoon games. For other locations, the more general version of this advice: Avoid facing the sun.

Choosing a Direction

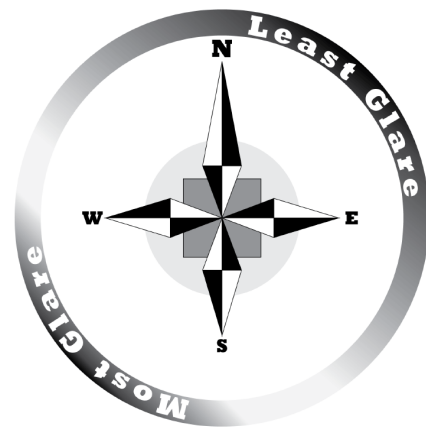

Play clock sets may be purchased in a portable configuration, which typically clears away any problems with accessibility. For portable systems, the planning is more likely to be focused on running power to the locations you need. For permanently installed play clock displays, it is important to remember that the football players, who are likely to be tall, will want to see the clocks over the heads of their teammates and opponents.

Unless you've selected a very small scoreboard for a very large field, viewing distance is not usually an issue. The rule of thumb in the sign industry is that, for lighted characters, every inch of height provides 50 feet of viewing distance. For comfort, and because you also need to read the captions (on most scoreboards), we prefer to recommend 25 feet of viewing distance per inch of digit height. Model LX3018 uses 18-inch tall digits, meaning the play clock displays can easily be seen from 450 feet.

The height of the play clocks above the ground is important for several reasons. For safety, you don't want to position any sign where people are likely to smack their heads into it. Also, when they are easily within reach, the power and other cables running into the cabinets can prove tempting to bothersome hands. For these reasons, as well as visibility above players on the field, you should usually keep the bottom of each play clock display at least eight feet above ground level. While there is theoretically no upper limit on the height, you must consider stability of your structure and serviceability.

In other words, the taller the sign, the larger the posts and footings will need to be. And, the taller the sign, the more difficult it will be to service.

Other factors, such as the availability of power or the nature of the terrain (too rocky or too swampy), can play a role in determining play clock display location. When in doubt, feel free to discuss options with your scoreboard sales rep.

The sections that follow in this document discuss the details of mechanical and electrical installation of a pair of play clock displays. If your project includes multiple play clocks, scoreboards, or other electronic displays, please check with your scoreboard sales rep to make sure you have any project-level documentation you may need.

Before You Spend Your Time and Money...

Please keep in mind that the dimensions and other details referenced throughout this document are specific to the standard configurations of this particular set of play clocks. Before purchasing materials, digging holes, etc. you should verify with the factory that you have the right documentation for your unique project.

It is possible that a government agency, such as your local city council, will require a building permit or other documentation and approval forms related to the installation and operation of your play clock displays. In some cases, particularly in coastal regions where hurricanes are a concern, the installation plan may require a stamp from a locally licensed Professional Engineer (P.E.).

MECHANICAL INSTALLATION- PERMANENT CONFIGURATION

This section of the manual describes installing the play clock displays, in their standard configuration for permanent installation, on posts. If your scoreboard project includes customizations with additional ID panels or requires special mounting considerations, please contact Electro-Mech to request details specific to your project. If you have an existing structure and would like to change the position or size of our mounting hardware to accommodate it, we can probably help you out. But we need to find out BEFORE we start building the cabinets. Let your scoreboard sales rep know about any special requirements as early in the process as possible.

Additional Materials and Tools

All permanently installed scoreboard displays are attached to some sort of structure. It is beyond the scope of this document to provide detailed instructions on the wide variety of tools and techniques available to build a sign support structure. In most cases involving outdoor scoreboard displays, the structure consists of two or more steel posts, each set in a concrete footing. In the case of play clock displays, only one post is needed for each cabinet. What follows assumes this type of structure. This document also assumes the installer has access to tools and skills for...

- Digging holes for footings
- Mixing and pouring concrete
- Lifting posts into position
- Keeping the posts aligned until the concrete sets
- Lifting the scoreboard cabinets

Electro-Mech recommends you find a reputable sign installer with the equipment and experience to handle the work mentioned above. If you are unfamiliar with sign installers in your area, contact your scoreboard sales rep for recommendations.

Other than the equipment and materials outlined above, the main items required to complete the mechanical installation are...

- Two posts (1 per display)
- A 3/4-inch SAE wrench or socket set to tighten the clamps

Types of Posts

Here are some good choices for posts:

- **6-inch Schedule 40 steel pipe**
(actual outer diameter is 6.63 inches)
- **W6x25 I-beam**
(width=6.08 inches, depth=6.38 inches)
- **7-inch square (or box) tube**
with a minimum of 1/4-inch thick walls

The shape and material of the posts is important only in the sense that the posts must be strong enough to support the load they will carry. Other than this general condition, the main limit imposed by the scoreboard is that the posts have to fit inside the mounting clamps (assuming you wish to use the hardware provided by Electro-Mech). The standard clamps form a "pocket" that is 7-1/2 inches square. So, if you try to use a 10-inch diameter pipe, our clamps will not work.

Mounting Clamp Assembly

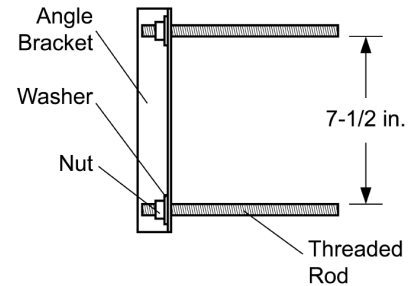

Mounting Clamps

Model LX3018 ships with four Mounting Clamp Assemblies (two per cabinet) — possibly more, if there are additional ID panels or other customizations. Each assembly consists of an Angle Bracket, two Washers, two Nuts, and two Threaded rods. The pieces fit together as shown in the diagram above.

Overhead Cross-Section View of a Mounting Clamp Assembly on a Typical Post

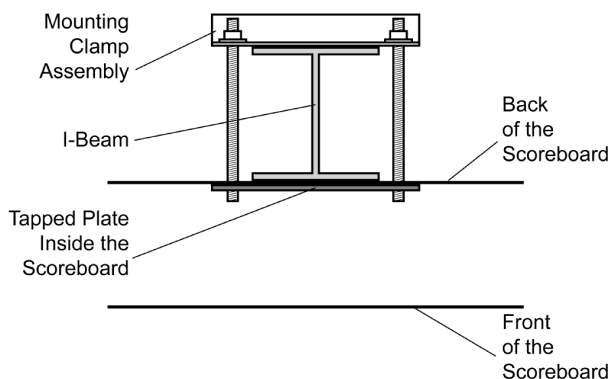

Each Mounting Clamp Assembly mates with a Mounting Point on the back of one of the scoreboard cabinets. These Mounting Points consist of tapped steel plates riveted inside the cabinet along the top and bottom of the back. The idea is to sandwich a post between the back of the play clock display and the angle bracket of the Mounting Clamp Assembly. When you tighten the nuts against the angle bracket, you clamp the scoreboard cabinet to the post. Using the standard mounting clamps provided with the play clocks, you can

mount each cabinet on a post without having to cut or drill any metal parts and without having to weld pieces together.

Post Length and Footings

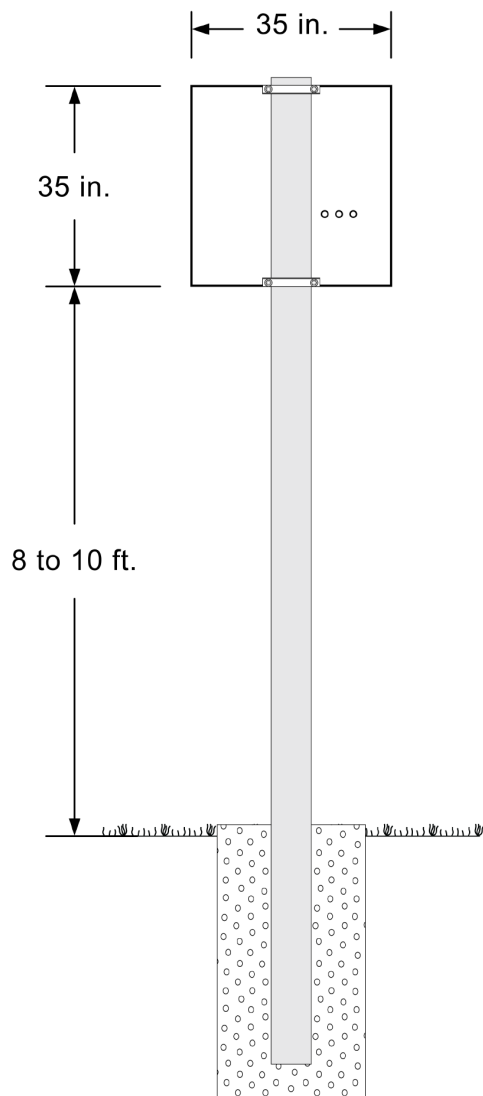

The length of your posts is determined by the configuration of your scoreboard display, its height above the ground, and the depth of your footings. Footing size is also related to the cabinet height and configuration. To some degree, the depth of the footings will be determined by the equipment available to the installer. In general, a smaller diameter hole needs to go deeper than a larger diameter hole. The trick is to create footings hefty enough to provide stability for the sign structure.

In many cases, one of the play clock displays will share a post with the main football scoreboard display. In this case, post length and footing size will be dictated by the overall structure. For a play clock cabinet mounted by itself on a post, a concrete footing two feet in diameter and three to four feet deep is typical. Given the 3-foot tall cabinet, assuming you have three feet of post in the ground, and adding eight feet for the distance between the ground and the bottom of the cabinet, your post would need to be fourteen feet long.

In some locations, building requirements may dictate that footing design and pole selection require "stamped" drawings from a Professional Engineer (P.E.) licensed to operate in the area. A Professional Engineer will be familiar with local requirements concerning wind loads and other factors that may affect the size, position, and number of posts and footings. Your Electro-Mech

sales rep can work with you to meet any special needs that arise from the a Professional Engineer's design work, as long as we are aware of those needs BEFORE the play clocks go into production. It is always best to consult with your local building authorities and a local sign installer before finalizing the details of an installation.

Attaching a Play Clock Display to a Post

After the concrete sets, you may clamp the play clock cabinet to a post. If your project includes any ID panels mounting above or below the play clock display, start from the bottom cabinet and work your way up. Or you could mount the play clock display to one of the posts supporting your main football scoreboard display. You may lift the cabinets into place using a crane or other mechanical device. Or, for smaller installations, a few willing volunteers can lift each cabinet and hold it while someone else tightens the clamps. Here are a few simple steps for handling the cabinets and clamps:

1. Begin with the bottom cabinet piece.
2. Rest the cabinet on the ground with its back to the posts.
3. Align the mounting points with the posts.
4. Thread the rods into the tapped holes in the back of the cabinet.
5. Slide the angle bracket over the rods at each mounting point.
6. Slide a washer onto each rod (behind the angle bracket).
7. Loosely install the nuts.
8. Raise the cabinet into position on the posts.
9. Tighten the nuts so that the cabinet is secure.
10. Remove the eye bolts from the top of the cabinet.
11. Set the next cabinet on top of the this cabinet.
12. Repeat steps 3 through 7.
13. Raise the cabinet slightly – leaving a 1/4-inch gap between cabinets for drainage.
14. Tighten the nuts so that the cabinet is secure.
15. If there are additional cabinets, remove the eye bolts from the previous cabinet and repeat the steps 11 through 14.

A few tips about what NOT to do when installing a play clock display:

- Don't attempt to clamp the post to the play clock cabinet and THEN raise the structure into place. The cabinetry is not designed to support the weight of a steel pipe or I-beam. Lifting a play clock display with a post attached is likely to warp the cabinet.
- Don't try to bolt various cabinets together and lift them. This is another path to warped cabinetry.
- Don't hang the play clock display before your concrete footings have time to cure.
- Don't mount the play clock cabinet at a height (or in a location) where people are likely to bump their heads on it or be tempted to bother the cabling.
- Don't block the drain holes.
- Don't walk away from the project without installing a ground rod.

MECHANICAL INSTALLATION - PORTABLE CONFIGURATION

This section of the manual discusses the mechanical details of play clock displays designed for portable use. You may provide a permanent structure if you like. But, in most cases, these displays will be mounted on a portable stand. Electro-Mech offers a "T-Card" portable leg kit for this purpose. Instructions for attaching the portable leg kit are provided in the documentation that ships with that product.

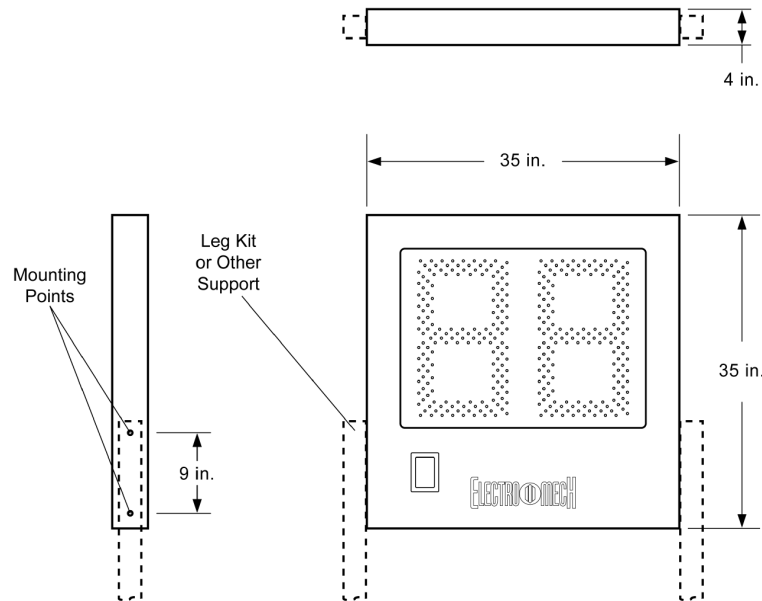

If you wish to attach your play clock displays to a different support structure, you may take advantage of the mounting plates included in the cabinets. These plates have tapped holes, spaced nine inches center-to-center, along the sides of each cabinet. The tapped holes accept 1/2-inch-13 threaded bolts. For Model LX3018, support brackets or posts would need to be positioned 35 inches apart (inside spacing) to provide room for the cabinet.

ELECTRICAL INSTALLATION - PERMANENT CONFIGURATION

This section of the manual describes hooking up power and data cables to play clock displays configured for permanent installation. Skip past this page if your play clocks are designed for portable use.

The standard configuration of this play clock set requires power cables (and any other external connections) to enter through openings in the backs of the cabinets. If your facility requires access via some other means — for instance, if you need to mount the play clock displays on a wall — we can provide other options for routing cables. Let your scoreboard sales rep know about any special requirements BEFORE we begin building your cabinets.

Overview of Electrical Connections

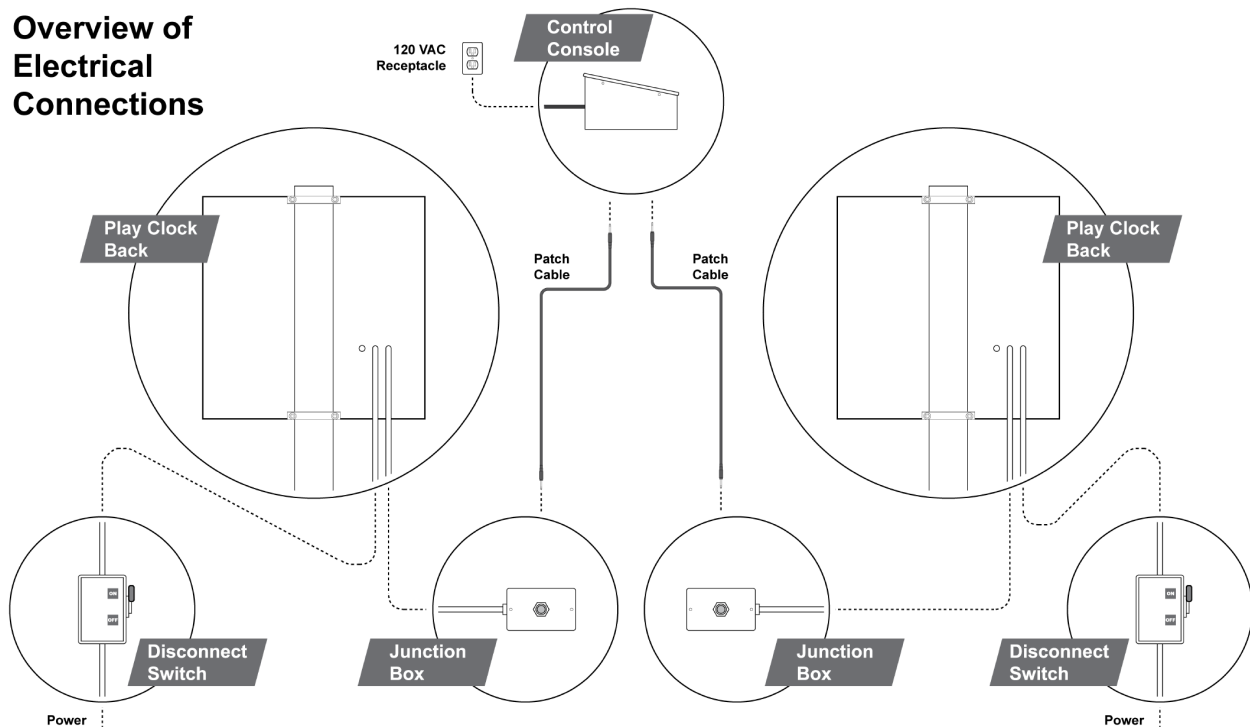

Power Considerations

All permanently installed scoreboard displays require a 120 VAC 60 Hz power source. This AC power may come from an inverter attached to a battery charged by solar energy, a gasoline powered generator, or the local power company. It is beyond the scope of this document to consider all the possible variations. We will be concerned here with only the last few feet the power cable will travel as it enters the scoreboard cabinet.

Model LX3018 draws a maximum of 0.4 amps at each cabinet. Make sure your power system can supply this load and that your power cables are rated to support the load over the distances they must travel. We recommend running power cables in conduit wherever they would otherwise be exposed. Never run power and data cables in the same conduit. If you run your cables underground, maintain at least twelve inches distance between power and data cables.

Additional Materials and Tools

The main items required to complete the electrical installation are...

- Two ground rod kits (and a mallet to drive the rods into the ground)
- Power cables (typically 12 AWG)
- Two disconnect switches and weather-tight enclosures
- Two convenience receptacles (optional)
- Data cables (unless you've purchased a ScoreLink wireless data system)
- Wire splicing kit for use with 22 AWG wire (if data cable is used)
- Conduit, fittings, and tools for cutting and bending the conduit
- Crimp terminals and crimping tools, including wire strippers
- 1/4-inch hex nut driver
- Common tools such as Phillips and flat head screwdrivers, a knife, etc.

This document assumes the installer has access to tools and skills for...

- Working with conduit and fittings
- Routing cables
- Trenching
- Crimping terminals, splicing, soldering, and other basic wire management
- Minor carpentry work

Electro-Mech recommends you find a reputable sign installer or electrician with the tools and experience to handle the type of work mentioned above. If you are unfamiliar with sign installers in your area, contact your scoreboard sales rep for recommendations.

Step-by-Step Guide to Connections at the Play Clock Displays

Step 1: Run the power and data cables.

As mentioned on the previous page, each play clock display requires AC power. And, unless you have purchased the ScoreLink wireless data communication package, you will need to run data cable from the point of operation (usually the press box) to each display. We cannot give a full blown tutorial on trenching and other techniques for running cabling, but we can provide a few tips.

- Electro-Mech can supply burial quality data cable.
- If you run data and power cables in the same trench, keep them separated by at least twelve inches of dirt.
- Use conduit to protect your cables wherever they would otherwise be exposed.
- The knockouts in the back of each play clock cabinet allow fittings for 1/2-inch or 3/4-inch conduit to tie directly to the back of the display.
- Consider using conduit even for underground sections of your cable runs to provide added protection and ease of access if the cable needs to be replaced in the future.
- Don't run power and data cables in the same conduit.
- When running data cable to multiple scoreboard displays, you should never split the signal; either use additional outputs on the control console for secondary runs, or daisy-chain from one display to the next.

Step 2: Install a disconnect switch (and, optionally, a convenience receptacle) for each play clock display.

The National Electric Code (Article 600.6) requires a disconnect switch for any electric sign. Typically the disconnect switch is installed on one of the posts supporting the play clock display. Since scoreboards are often installed away from buildings and other structures likely to contain power receptacles, it is a good idea to install a convenience receptacle in line with the disconnect switch. You won't need the receptacle for normal scoreboard operation, but it may come in handy for plugging in tools during installation or later in the life of the display.



Step 3: Remove the Play Clock digit assembly from the front of the scoreboard.

In its standard configuration for permanent installation, the Model LX3018 Play Clock Set offers front accessibility to all serviceable components and connection points. To attach power cables and make other electrical connections, you must remove the Play Clock digit assembly from the front of each cabinet.

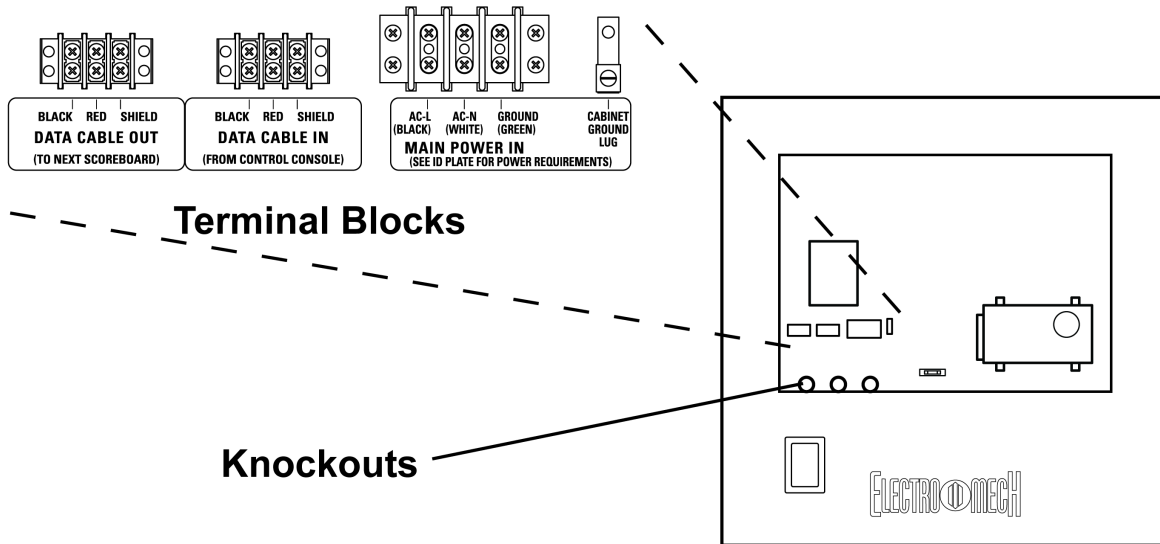

The digit assemblies are held to the face of each play clock cabinet by several machine screws. As you remove the final screw holding the metal mask to the display face, make sure to support the assembly with your hand. Remove the ribbon cables from the back of each digit. Set the assembly and screws aside while you complete the electrical connections.

Step 4: Attach a ground rod to each play clock cabinet.

Ground rods are required by the National Electric Code (Article 600.7) and are an effective way to make your scoreboard system less susceptible to damage from nearby lightning strikes and other power-related problems. We recommend an (at least) 8-ft. copper ground rod driven into the earth near each play clock display. You may attach the wiring from the rod to the outside of the cabinet or to the ground lug next to the Main Power terminal inside the cabinet.

Although your play clock displays may be attached to steel posts, the posts do not make good ground rods. Steel will corrode over time. Any finish applied to the steel to slow down corrosion will usually insulate the metal, as will concrete footings.



Step 5: Bring power to the each play clock cabinet.

At each play clock display, bring your AC power cable (via conduit from the disconnect switch mentioned in Step 2) through one of the knockouts in the rear of the cabinet. Make sure your power cable is sized sufficiently to handle the current required by the sign. Attach the wires to the Main Power terminal block. We recommend adding crimp-on fork terminals to the end of each power wire.

Step 6: Bring data to each play clock cabinet.

If you've purchased the ScoreLink RF Communications system, your play clock displays already have wireless client devices installed. Your work here is done; move on to the next step.

If you have chosen to send data to the play clock displays using cable, bring the data cable (via conduit) through one of the knockouts in the rear of each cabinet. Attach the wires to the Data Cable In terminal block, matching the colors as shown below. We recommend adding crimp-on fork terminals to the data wires.



You may purchase data cable from the factory, or you may source it elsewhere. We recommend (and supply) cable that is rated for direct burial. It includes two insulated 22 AWG stranded conductors (red and black), along with a non-insulated conductor, all wrapped by a braided or foil shield. This document will discuss, in a few pages, what the other end of this cable is connected to.

You may optionally create a "daisy chain" of displays by running additional cable from the Data Cable Out terminal of one play clock display to the Data Cable In terminal of another display (such as the other play clock).

Step 7: Replace the LED digit assemblies.

Attach the ribbon cables to the digit PCBs. Then attach the assemblies to the play clock faces using the machine screws (from Step 3). You didn't drop any screws, right?

Junction Box and Data Cable

If your play clock package includes the ScoreLink wireless communication system, your work is done here. Skip to the section about the control console.

Your hard-wired play clock package includes two junction boxes, which you should permanently mount to provide stable points of termination for the data cables. The idea is to connect the main football control console to these junction boxes via two ten-foot patch cables. In the case of play clocks, the same control console is typically used to control a full sized football scoreboard display. The junction boxes will need to be mounted within ten feet of the position where your scoreboard operator will sit. In most cases, the play clock operator will use a wired three-button controller, plugged into the main football control console, to manage the play clocks during the game. If you plan to operate the scoreboard system from an

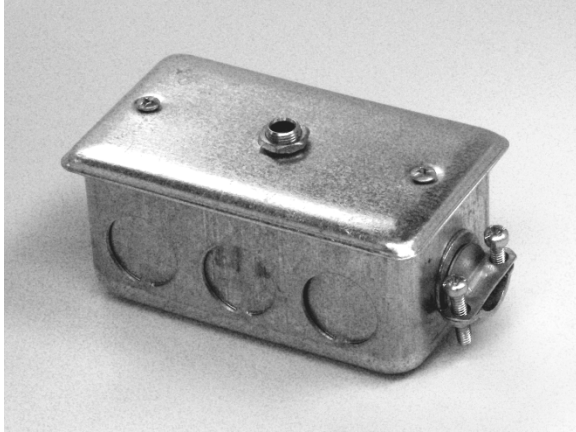

enclosure (such as a press box) that will remain dry and clean, you may mount the junction boxes directly to an interior wall or in some other protected area. If you plan to operate the scoreboard displays from a position that will be exposed to weather, you should mount the junction boxes inside a weather-tight enclosure. Exposure to moisture, dirt, etc. will eventually corrode the connection points in the junction boxes and interfere with signals sent to the play clock displays.

It is a good idea to mount the junction boxes where they are not likely to be stepped on, tripped over, or kicked. It is also important to label your junction boxes. The connectors used for scoreboard data look very much like the type used in some audio systems. Plugging audio devices into a scoreboard data line can possibly damage the scoreboard system.

The junction boxes ship with a length of cable soldered to the stereo socket and tucked inside of each box. There should be no need to solder cable to the stereo sockets during the installation. Instead, splice the wires from the data cables to the pigtail inside the junction boxes, matching colors. The wires in the pigtails are 22 AWG, and the cables should use the same size conductors. The installer must provide wire nuts, crimp splices, or other means to connect the wires.

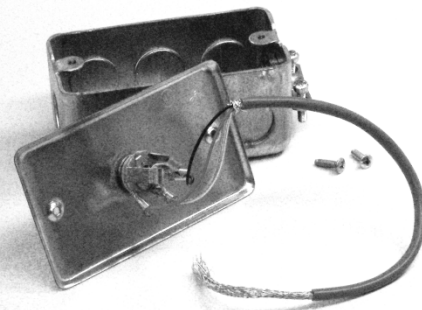

The splice point should stay inside of each junction box. That is, you want to feed the long run of cable into the box rather than

pulling the pigtail out. Electro-Mech provides a strain relief on one side of the junction box to secure the cable. You may choose to connect conduit directly to the junction box, in which case the strain relief will not be needed. The junction boxes are designed to accept 3/4-inch conduit fittings.

We recommend running data cable in conduit from each junction box to each play clock display — especially where the cable would otherwise be exposed. You should never run data cable in the same conduit as power cable. Having more than one run of scoreboard data cable in a single conduit is perfectly fine.

One more warning about data cable: Never split or branch the cable. The current loop signal we use to transmit data to our play clock displays will behave unpredictably if it is divided between two destinations. There are other options for getting synchronized data to two locations, including daisy chaining from one display to the next. If your facility calls for a more complicated cabling plan, it is best to work out the details with your scoreboard sales rep prior to installation.

Connections at the Control Console

The standard control console packaged with this scoreboard system is powered through a typical three-prong AC power cord. At the point of operation, the console requires a grounded power receptacle.

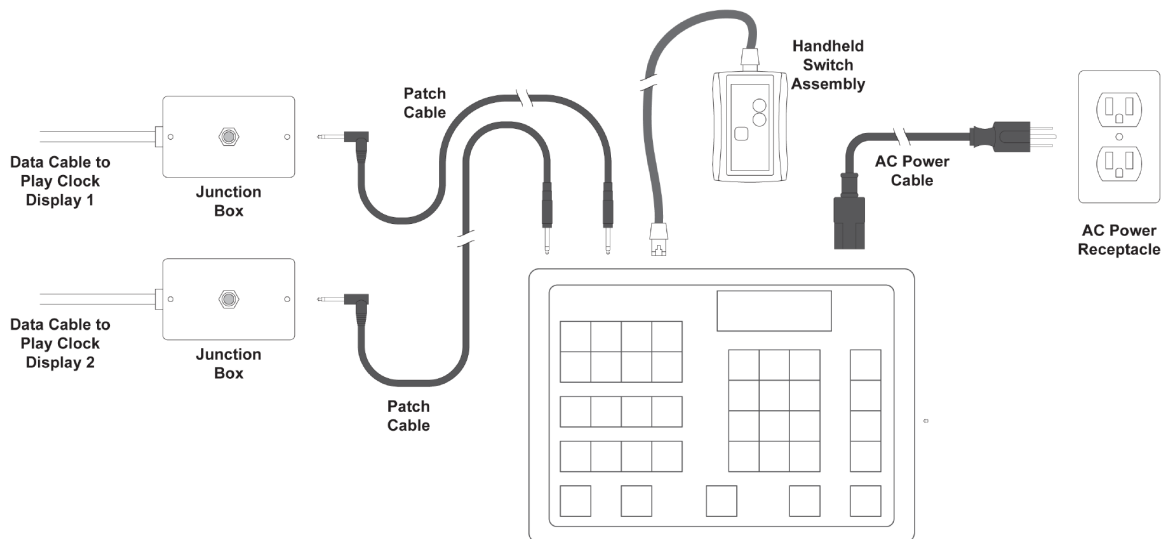

If your play clock package includes a ScoreLink RF Communications system, the power receptacle may be the only consideration on the control console side of the installation process. For details about ScoreLink, consult the documentation that ships with the product. Otherwise use the stereo patch cables to plug the console into the junction boxes.

ELECTRICAL INSTALLATION - PORTABLE CONFIGURATION

This section of the manual describes hooking up power and data cables to play clock displays configured for portable use.

The standard configuration of this play clock set requires power cables (and any other external connections) to plug into sockets in the backs of the cabinets. If your facility requires access via some other means — for instance, if you need to mount the play clock displays on a wall — we can provide other options for routing cables. Let your scoreboard sales rep know about any special requirements BEFORE we begin building your cabinets.

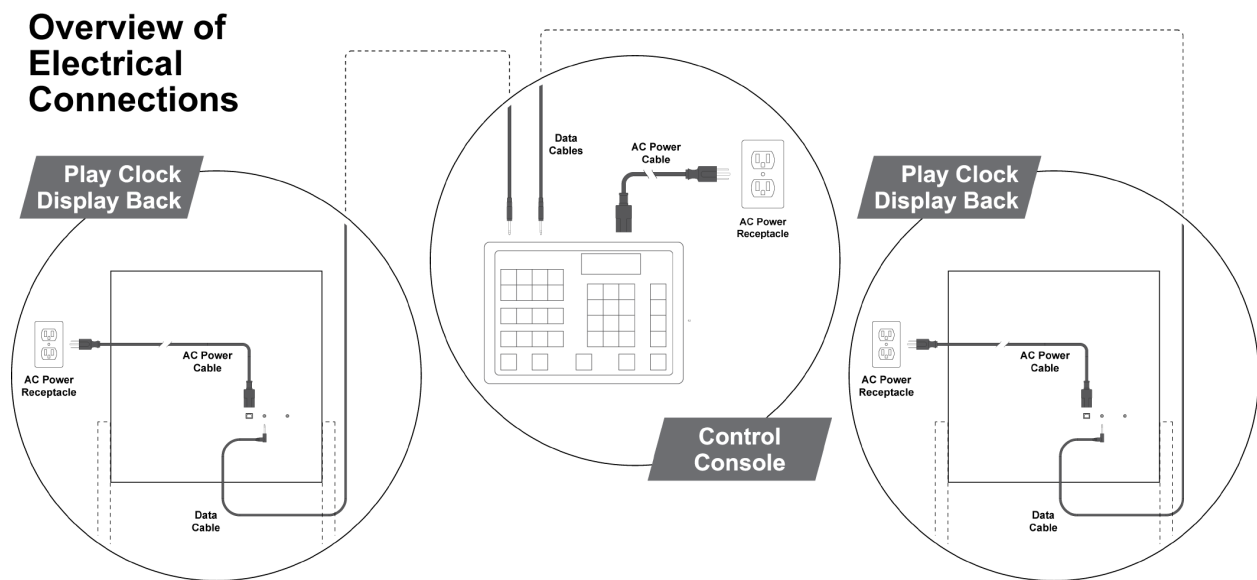

Each play clock cabinet requires a standard power receptacle. If you prefer, you may use a drop cord to bring power to the displays. Electro-Mech provides a detachable power cord with GFCI safety circuitry for each portable display. Plug these cords into the AC power sockets on the backs of the two play clock cabinets. We recommend testing (and resetting) the GFCI feature when you first plug the displays into power receptacles.

Your power source must be able to provide 120 VAC, 60 Hz, 0.4 amps to each play clock display. In addition, the control console will require a receptacle meeting these same specifications.

For portable play clock packages shipped with our ScoreLink RF communication system, there should be no additional steps for setting up the electrical connections. For hardwired systems, the data connection may be as simple as plugging in patch

cables running from the output ports on the back of the main football control console to the input ports on the backs of the two displays. If your project requires more complicated options for the data connections, please discuss the details with your scoreboard sales representative to make certain we provide the materials you will need.

TESTING, OPERATION, AND ONGOING CARE

After all power, data, and other connections are in place, it is time to test the play clock system. Apply power to the play clock displays first. Although there is no harm in powering the control console first, powering the signs first should result in the numeric displays to remaining blank. Seeing any LEDs illuminated on one of the play clock displays prior to the availability of data from the control console would indicate a problem inside of the play clock cabinet.

Next, power up the control console and plug in the three-button handheld switch assembly. For wired setups, connect two stereo patch cables to data output ports on the back of the control console. For portable play clocks, the other end of these patch cables are typically plugged into the data input ports on the backs of the displays. For permanently installed play clock displays (and some portable ones), the stereo patch cables are typically plugged into junction boxes.

The play clock displays should begin showing data within a few seconds. Use the three-button handheld device to start, stop, and reset the play clock time. The [PLAY CLOCKS] button on the control console should allow you to change the time showing on the displays. For more details about how the control console and handheld switch assembly work, consult the documentation that ships with them.

Scheduled Testing and Maintenance

Play clocks configured for portable use ship with detachable power cords. These power cords include GFCI safety circuitry. We recommend using the test feature of the GFCI power cords the first time you apply power to the displays. Continue testing at three month intervals over the life of the product. To activate the test feature, first plug the cord into your power source. Press the [TEST] button. At this point, the GFCI LED indicator should not be illuminated. Press the [RESET] button. Now the LED indicator should illuminate. If the cord fails the test, replace it with a new GFCI power cord.

The rest of the system does not require scheduled maintenance procedures. However, it is important to check for problems prior to a game. We recommend running through the operational tests between two and four weeks prior to the start of a season (or anytime you plan to use the play clocks after a gap of more than a month). During the season, test out the play clocks the day before each game.

After the Game, and After the Season

Whenever you are not using your play clock system, disconnect the displays from power. Portable displays should be unplugged from both power and data cables and stored in a secure area. For permanently installed systems, use disconnect switches to cut power to the signs. You should unplug the control console from its power source and from the data cables as well. It is not necessary to take steps beyond this, even if the play clocks will not be used for several months.

MAINTENANCE

We hope your play clock system provides years of trouble free service. In the event of a problem, the material that follows will provide some information about contacting technical support as well as some details about the parts inside your play clock displays.

Contacting Technical Support

Our support staff is available via phone or e-mail Monday through Friday 8:00 through 5:00 Eastern. Our web address and phone number is printed at the bottom of this page. When contacting Electro-Mech for support, it helps to have the scoreboard model (**LX3018**) handy as well as the version of the software running on your control console. If your control console includes an LCD display, you will see the software version flash briefly (for about three seconds) on the screen when you first apply power. Whether you have the LCD display or not, you should find on the bottom of the control console a product label which gives the software version.

If you are reading this manual in search of help with a different scoreboard model, for outdoor scoreboards, you can find the model number printed on a metal plate attached to the back of the scoreboard cabinet near where the power enters. For indoor scoreboards, the model number is usually printed on a label at the top center of the cabinet near the attachment point for the power cable.

If you are troubleshooting a problem, the most important information to have is an exact description of which parts of your scoreboard system are working and which parts are not working. The best person to make contact with our support team is someone who has seen the problem first hand. Better yet, give us a call when you are there at the scoreboard display and can walk through a few simple tests with one of our technicians.

Scoreboard problems are rarely so complicated that diagnosing them requires skills beyond using a screwdriver and a ladder. Similarly, replacing parts is straightforward process that does not require complex tools or special knowledge.

Parts Exchange

If, after working with our support staff, you discover that a part needs to be serviced or replaced, the next step is to send the part to Electro-Mech for repair. During the warranty period, we repair parts and return them via UPS ground service at no charge. We can ship parts via overnight service for an additional charge. For work that falls outside of the warranty terms, we can, upon request, provide an estimate of repair costs on returned parts before performing the work. The typical turnaround on repair work is less than three business days

Electro-Mech maintains a supply of common parts for immediate shipment. Some customers choose to purchase new parts for immediate use and will later send old parts back to us to be repaired and returned as "backup" stock. In some cases our support plans include the option for shipping replacement parts to the customer once our service staff has identified a problem. The customer will then return the damaged part after receiving the replacement. Electro-Mech requires a valid credit card number before initiating a shipment of this type. We do not apply charges to the card unless the customer does not return parts within ten days or if the returned parts require work outside of our warranty terms.

Our shipping address:

Electro-Mech Scoreboard Co.
72 Industrial Blvd.
Wrightsville, GA 31096

Location of Serviceable Parts

All serviceable parts are located behind the digit assembly, which makes up most of the face of each play clock display. If your play clock display includes a ScoreLink RF receiver unit, it will be accessible just below the LED digit assembly.

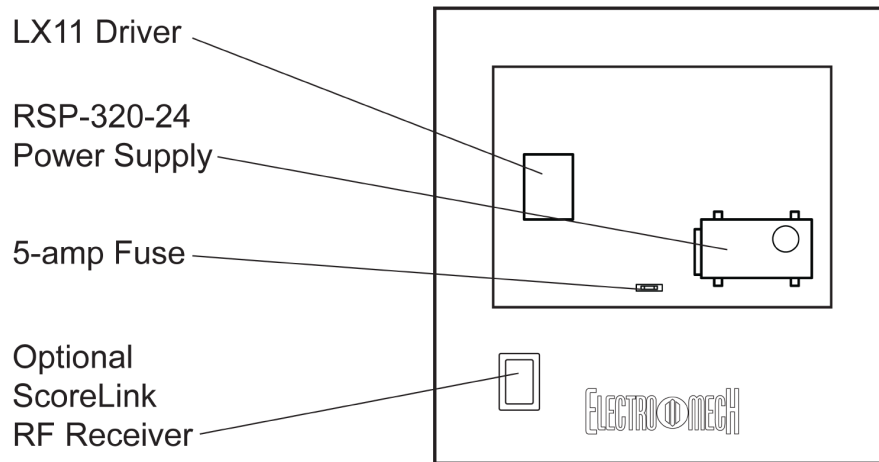

Illuminated PCB Assemblies

The LED assemblies and circuit boards (but not individual LEDs) are field replaceable parts. Each LED is soldered to a printed circuit board (PCB) which is, in turn, attached to a protective metal mask. The mask assembly is attached to the scoreboard face with machine screws. You will need a 1/4-inch nut driver to remove these screws.

Removing an LED Assembly, Step-By-Step:

- Disconnect power to the play clock cabinet before performing any service work.
- Remove the machine screws from the metal mask, leaving for last one of the screws along the top of the mask.
- Support the mask with one hand as you remove the final screw.
- Rotate the mask so that you can see the PCB (or PCBs) behind it and the cable connections along the back side.
- Unplug the ribbon cables, and, if present, the power cables from the PCBs.
- Set the LED assembly aside and save the screws for later.

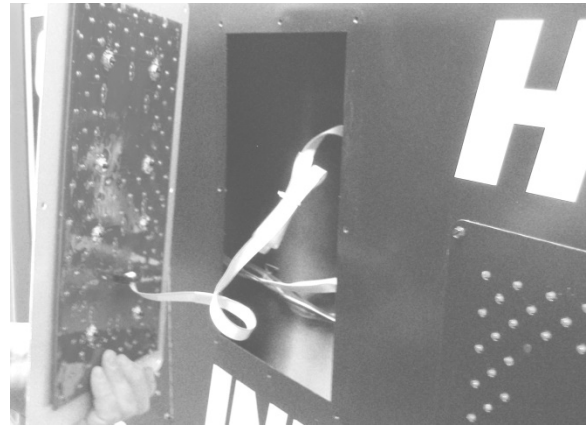

If your purpose in removing the LED assembly was to provide access to the components behind it, you may skip the next part about removing and replacing the LED printed circuit board.

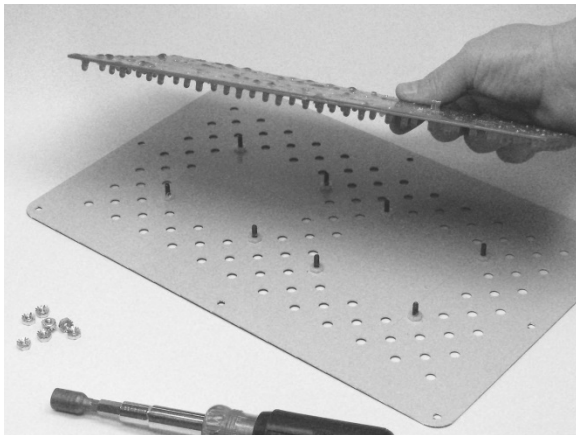

The LED circuit board is held to the mask by several nuts, which you can remove using a 3/8-inch nut driver. On outdoor displays the thick conformal coating can be messy, as the lock washers on the nuts dig into the coating and knock pieces of it away. Be careful to keep the whole assembly right side up when you return it to the play clock cabinet.

Power Supplies and Fuses

AC power enters through the back of each play clock cabinet. When the play clocks are configured for portable use, the AC power sockets on the cabinet backs serve as the points of entry. When the play clocks are configured for permanent installation, the installer brings the power cable to a terminal block, accessible by removing the digit assembly from the front of the cabinet. From the power terminal block, the line side of AC passes through a 5-amp fuse on the way to the Mean Well RSP-320-24 power supply module. This is an AG style fuse, which should only be replaced with a fuse of the same style and rating.

Power connections are made along a row of screw terminals on one side of the power supply module. The Mean Well RSP-320-24 module in each cabinet provides 18.9 VDC to the illuminated digits and their driver. If you replace a power supply module, check the output voltage to make certain it is set to 18.9 VDC.



LX Drivers

LX Driver circuit boards do the work of interpreting data sent from the control console to scoreboard display(s). Using that information, the drivers decide which of the LEDs should be illuminated and which should not. The LX11 Driver decodes play clock time and supplies signals via ribbon cables to the two LED digits in each play clock cabinet. The table below lists the names and purposes of the various connectors on the LX11 Driver.

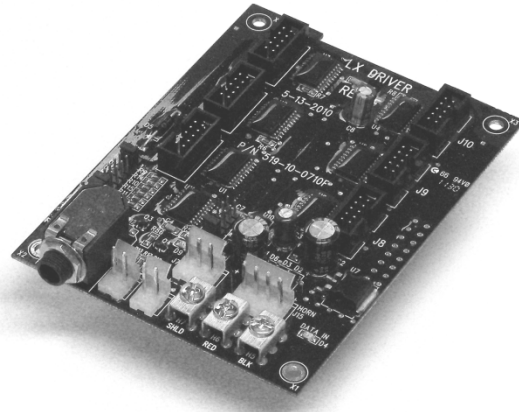

LX11 Driver Functions	
Connector	Function
J2 (Data In)	From ScoreLink
J3 (Data Out)	To Data Out Terminal Block
J4 (Word 1 Low)	Play Clock Ones
J5 (Word 1 High)	Play Clock Tens
J6 (Word 2 Low)	
J7 (DC Power In)	18.9 VDC
J8 (Word 3)	
J9 (Word 2 High)	
J10 (Word 4)	
J15	
H5/BLK (Data In)	From cable
H6/RED (Data In)	From cable
H7/SHLD (Data In)	From cable
Jumper Pins	X = Shunt Installed
H13 (J4/J5 Blanking)	
H16 (J4/J5 Blanking)	X
H14 (J6/J9 Blanking)	
H17 (J6/J9 Blanking)	
H15 (Not Used)	
H18 (Test Prog)	
H3 (Horn2 No Dim)	
H11 (Horn1 No Dim)	
H19 (Not Used)	
H1 (Memory Ret.)	
H2 (Group +1)	
H4 (Bank +2)	
H12 (Bank +1)	X

LIMITED WARRANTY STATEMENT

**Electro-Mech Scoreboard Company
Standard Equipment Warranty and Limitation of Liability
for Scoreboards and Accessories Sold in the United States**

Warranty Coverage

Electro-Mech warrants to the original end-user that the Equipment will be free from Defects (as defined below) in materials and workmanship for a period of five years from the date of invoice. Electro-Mech's obligation under this warranty is limited to, at Electro-Mech's option, replacing or repairing any Equipment or Part thereof that is found by Electro-Mech not to conform to the Equipment's specifications. Any defective Part must be returned to Electro-Mech for repair or replacement. Equipment determined not to conform to specifications will be repaired or replaced and returned to purchaser with standard ground service transportation charges prepaid. Replacement Parts or Equipment will be new or serviceably used, comparable in function and performance to the original Parts or Equipment, and warranted for the remainder of the warranty period. Purchasing additional Parts or Equipment from Electro-Mech does not extend this warranty period.

Defects shall be defined as follows. With regard to the Equipment (excepting LEDs), a "Defect" refers to a material variance from the design specifications that prohibits the Equipment from operating for its intended use. With respect to LEDs, "Defects" are defined as LEDs that cease to emit light. The limited warranty provided by Electro-Mech does not impose any duty or liability upon Electro-Mech for partial LED degradation.

This limited warranty is not transferable.

Exclusions from Warranty Coverage

The limited warranty provided by Electro-Mech does not impose any liability upon Electro-Mech for:

- Damage caused by the unauthorized adjustment, repair, or service of the Equipment by anyone other than personnel of Electro-Mech or its authorized repair agents.
- Rental fees or other costs associated with lifts, cranes, or other tools and services used to access the Equipment.

- Damage caused by the failure to provide a continuously suitable environment, including, but not limited to (i) neglect or misuse (ii) a failure or surges of electrical power (iii) any cause other than ordinary use.
- Damage caused by vandalism, fire, flood, earthquake, water, wind, lightning, or other natural disaster, or by any other event beyond Electro-Mech's reasonable control.
- Costs associated with replacement of communication methods including but not limited to, wireless systems, copper wire, fiber optic cable, conduit, or trenching for the purpose of overcoming local site interference.
- Any statements regarding products or services made by salesmen, dealers, distributors, or agents, unless such statements are in a written document signed by an officer of Electro-Mech.

Limitation of Liability

In no event shall Electro-Mech be liable for any special, consequential, incidental, or exemplary damages arising out of or in any way connected with the Equipment or otherwise, including but not limited to damages for lost profits, cost of substitute or replacement equipment, down time, lost data, or injury to property, or any damages or sums paid by the purchaser to third parties.